

ASSEMBLY & INSTALLATION INSTRUCTIONS

B463

Arc 1 Light Bath Sconce 201310

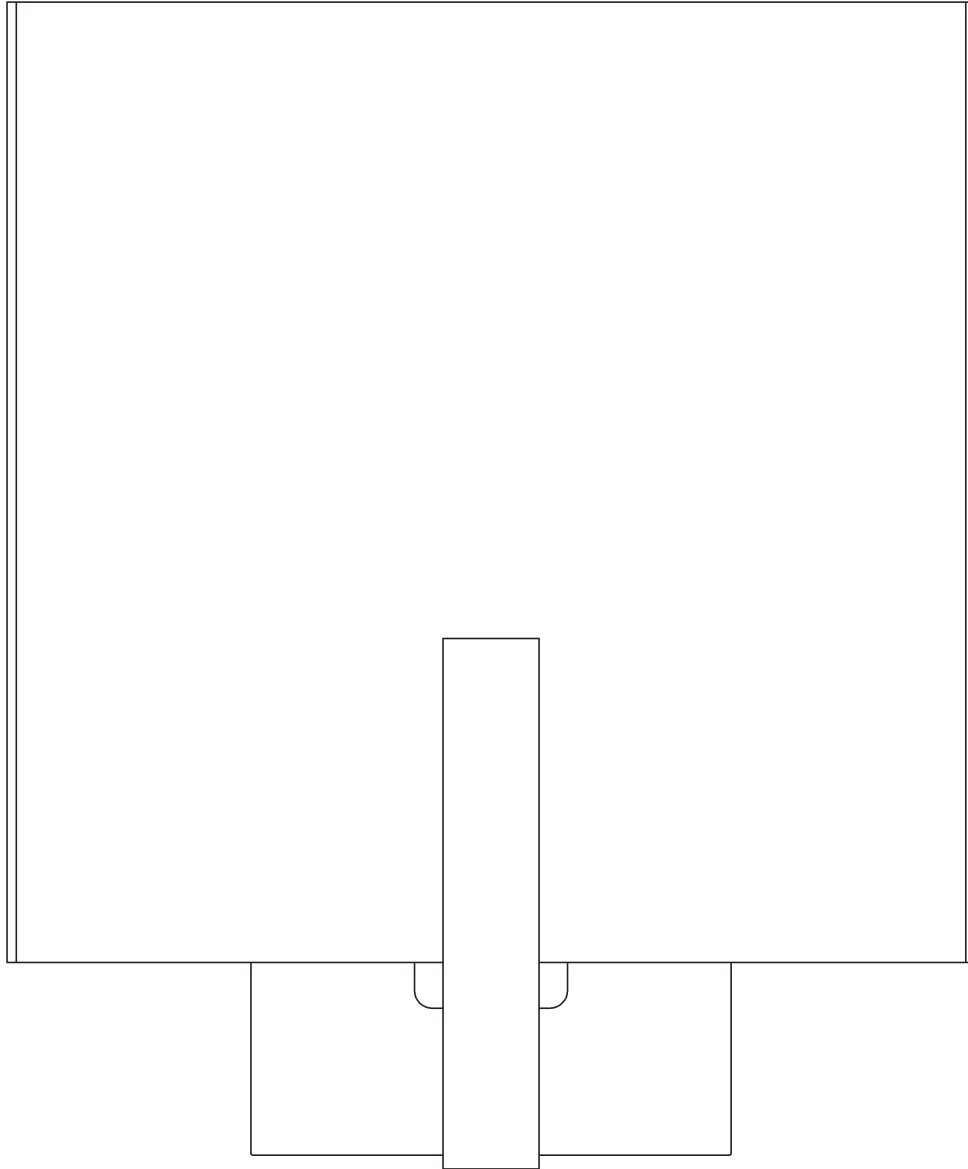

Component Parts

- A. Fixture**
- B. Mounting Bracket**
- C. Ground Screw**
- D. Cupped Washer**
- E. #8 Screws (4)**
- F. Socket**
- G. Bulb (Not Included)**
- H. Glass**
- I. Rubber Washer (4)**
- J. Knurled Ball (2)**
- K. Threaded Stud (2)**



Arc 1 Light Bath Sconce 201310

CAUTION: FAILURE TO INSTALL THIS FIXTURE PROPERLY MAY RESULT IN SERIOUS PERSONAL INJURY OR DEATH AND PROPERTY DAMAGE. We recommend installation by a licensed electrician. This product must be installed in accordance with applicable installation code(s), by a person familiar with the construction and operation of the product and the hazards involved.*

Caution: Do not exceed maximum wattage noted on fixture. Use only recommended bulbs with fixture.

Please Note: After installation extra hardware and accessories are possible; our kits are used on multiple products.

To Install Fixture (Figure 1)

CAUTION: BE SURE POWER IS OFF AT THE MAIN BREAKER BOX PRIOR TO INSTALLATION.

1. Carefully unpack the fixture (A) from the carton.
2. Remove mounting bracket (B) from fixture (A).
3. Thread the wires in the electrical box through the hole in the mounting bracket (B) while moving the bracket into position. Place mounting bracket over electrical box and secure with two machine screws (not provided).

Note: A new electric box comes with screws. When replacing a fixture, retain the existing screws for use.

4. Attach a pigtail lead to the mounting bracket (B) using the ground screw (C) and cupped washer (D) found in kit bag.
5. Hold fixture (A) close to wall. Using suitable wire connectors (not provided), connect fixture wires to supply wires (white to white and black to black). Connect all ground wires (bare copper or green to bare copper or green).

CAUTION: MAKE SURE WIRE CONNECTORS ARE TWISTED ON SECURELY, AND NO BARE WIRE IS EXPOSED.

6. Place fixture (A) over mounting bracket (B). Secure with #8 screws (E) on top and bottom of fixture. Be sure no wires are pinched between fixture and wall.
7. Follow steps on following page to complete installation.

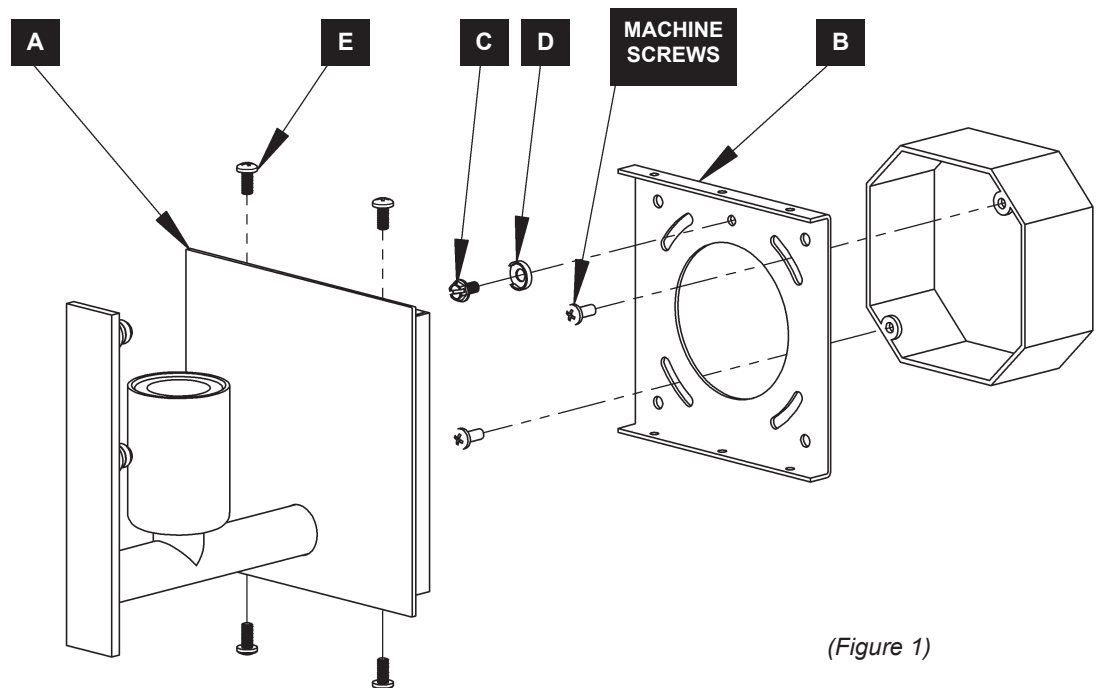

(Figure 1)

To Install Glass (Figure 2)

1. Rubber washers (I) and knurled balls (J) are shipped installed on the threaded studs (K). Remove washers (I) and knurled balls (J) and set aside.
2. Unpack glass (H). Slide glass (H) over the threaded studs (K).
3. Secure glass (H) with rubber washers (I) and knurled balls (J). Rubber washers (I) may not be needed, depending on glass (H) thickness.
4. Install bulb (G) (not included) into socket (F).
5. Restore electricity at main breaker.

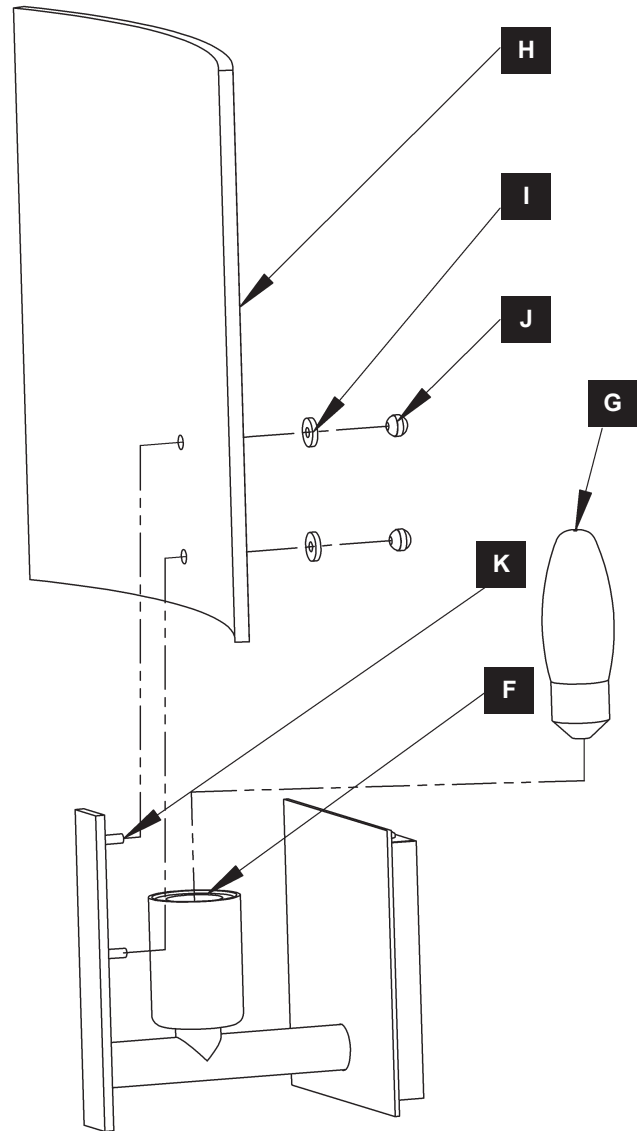

(Figure 2)

If you need further assistance, or find that you are missing any parts, please contact the dealer from which you purchased this product. We hope you enjoy your fixture!

*** Hubbardton Forge will not be liable for injury or damage caused by improper installation, lamping or use of this fixture.**